



vispronet®



## Barrier Signage



## Scaffold Advertising

[www.sachsenfahnen.com](http://www.sachsenfahnen.com)







# A-Frame

A-Frames are a perfect medium for portable outdoor advertising. They combine all the advantages of using smaller displays and large-scale barrier fences.

Various ground fittings for a wide range of grounds are available. This enables you to place barrier signage wherever you may need it. You can choose between single- or double-sided coverage of the fences and barriers. The banners can be fixed using cable ties.

## Arrangement options

as a single display

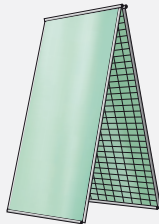

in a row

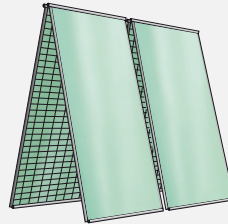

## Advantages

- versatile
- suitable for various grounds
- stable and sturdy
- can be dismantled for transportation
- quick exchangeable banners
- single- or double-sided coverage possible

## A-Frame

System dimensions W x H	200x335 cm
Footprint	200x200 cm
Advertising print W x H	174x338 cm
Material Advertising print	<ul style="list-style-type: none"> <li>· PVC banner Frontlit B1, 510g/m<sup>2</sup></li> <li>· Mesh Basic B1/M1, 300g/m<sup>2</sup></li> <li>· Mesh Premium B1/M1, 350g/m<sup>2</sup></li> </ul>
Finish	<ul style="list-style-type: none"> <li>· all sides hemmed, eyelets each 50 cm (a total of 22 eyelets)</li> </ul>

## Ground fittings



Concrete Base



Ground Spike

Application	solid grounds	bad grounds
Size	WxHxD: 22x13x70 cm	WxH: 4x4 cm, length 80 cm
Material	Concrete	Steel, galvanised
Weight	36.0 kg	2.9 kg
Number of pieces per barrier fence	4	4



# Single Panels

Single Panels are the most common option when using barrier signage. Covered with customised banners, they offer tremendous space for advertising.

The uses of Single Panels are not just limited to construction sites. They can be placed anywhere, for every target market. Select your ground fitting and use them in a variety of environments. You can choose the arrangement, either single or even a row!

## Arrangement options

Single panel

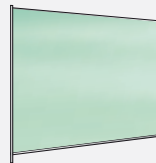

Double panel

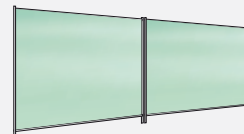

Triangular arrangement

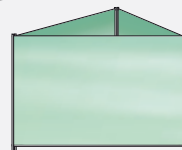

Square arrangement

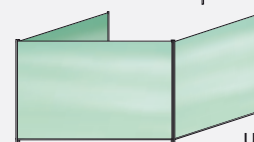
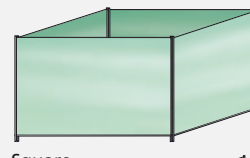

U-shape

L-shape

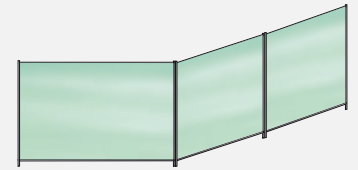

## Advantages

- suitable for various grounds
- unlimited arrangement options
- for short- and long-term use
- single- or double-sided coverage possible
- quick exchangeable banners

## Single Panel

System dimensions W x H	350x200cm
Advertising print W x H	338x174cm
Material Advertising print	<ul style="list-style-type: none"> <li>· PVC banner Frontlit B1, 510g/m<sup>2</sup></li> <li>· Mesh Basic B1/M1, 300g/m<sup>2</sup></li> <li>· Mesh Premium B1/M1, 350g/m<sup>2</sup></li> </ul>
Finish	<ul style="list-style-type: none"> <li>· all sides hemmed, eyelets each 50cm (a total of 22 eyelets)</li> <li>· multi-panel option available</li> </ul>



## Ground fittings



**Anchor Post**  
Base plate with 2 sleeves,  
4 anchor bolts



**Concrete Base**



**Ground Sleeve**  
Ground spike with 2 sleeves

<b>Application</b>	solid grounds, for long-term use	solid grounds, short- and long-term use	bad grounds, short- and long-term use
<b>Size</b>	Base plate 10x10cm, height 17cm, Ø Sleeve 4.5cm, height 15cm	W x H x D: 22x13x70cm	Total size W x H: 13x60cm, Ø Sleeve 4.5cm, Ø Spike 4.0cm
<b>Material</b>	Steel, galvanised	Concrete	Steel, galvanised
<b>Weight</b>	1.7 kg	36.0 kg	2.8 kg
<b>Number of pieces per barrier fence</b>	2	2	2



# Scaffold Advertising

Use scaffolds as a cost-efficient advertising space. Large-format banners for scaffolds are ideal to spread your message to a huge number of pedestrians. Construction companies, real estate companies and even shopkeepers alike choose scaffold advertising to promote their products and services.

Despite their low weight, large-format banners for scaffolds are extremely weather-proof and sturdy, suitable for long-term outdoor use. Depending on your requirements you can choose between a variety of material options.

Scaffold Advertising	1 Scaffold level	2 Scaffold levels
<b>Sizes W x H</b>	200 x 205 cm 250 x 205 cm	200 x 410 cm 250 x 410 cm
<b>Material Advertising print</b>	<ul style="list-style-type: none"> <li>· PVC banner Frontlit B1, 510 g/m<sup>2</sup></li> <li>· Mesh Basic B1/M1, 300 g/m<sup>2</sup>, recommended for high wind loads</li> <li>· Mesh Premium B1/M1, 350 g/m<sup>2</sup>, recommended for high wind loads</li> </ul>	
<b>Finish</b>	<ul style="list-style-type: none"> <li>· top and bottom edge with sleeve for pole Ø 50 mm</li> <li>· all sides hemmed and eyeleted, a total of 6 eyelets</li> </ul>	<ul style="list-style-type: none"> <li>· top and bottom edge with sleeve for pole Ø 50 mm</li> <li>· all sides hemmed and eyeleted, a total of 10 eyelets</li> </ul>
<b>Fixation</b>	<ul style="list-style-type: none"> <li>· slide two horizontal scaffold poles through the sleeves of the banner</li> <li>· additional fixation with elastic cords or cable ties</li> </ul>	



**Please note**  
Mounting brackets are available to attach large-format banners with a maximum height of 800 cm.

- fixation at the top and bottom edge of the large-format banner
- for vertical or horizontal attachment to scaffold braces with Ø 48 - 50 mm

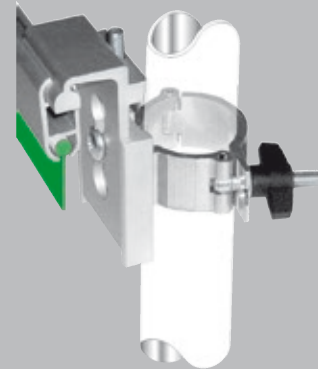

# Barrier Jackets and Fence Scrims

Crowd control barriers are used at many public events to guide visitors and to control large gatherings. Barrier Jackets and Fence Scrims turn the barriers into real eye-catchers. Customised with logos, messages or graphics, they offer efficient advertising space for companies, event organisers or sponsors.

Fence Scrims and Barrier Jackets are available in three different standard sizes. They fit to the most common crowd control barriers and barricades. The graphics get printed on sturdy, durable materials. The eyeleted Barrier Jackets and Fence Scrims can be quickly fixed to fences and barriers using cable ties, bungee ties or cord.



	Fence Scrims	applicable to crowd control barriers with a size of	Barrier Jackets	applicable to crowd control barriers with a size of
<b>Sizes (B x W)</b>	183 x 75 cm	200 x 110 cm	200 x 82 cm	200 x 110 cm
	213 x 75 cm	230 x 110 cm	230 x 82 cm	230 x 110 cm
	233 x 75 cm	250 x 110 cm	250 x 82 cm	250 x 110 cm
<b>Materials</b>	<ul style="list-style-type: none"> <li>· PVC banner Frontlit B1, 510 g/m<sup>2</sup></li> <li>· Mesh Basic B1/M1, 300 g/m<sup>2</sup></li> <li>· Mesh Premium B1/M1, 350 g/m<sup>2</sup></li> </ul>		<ul style="list-style-type: none"> <li>· Varioflag® A SE, 110 g/m<sup>2</sup></li> <li>· Non-woven polyester, 150 g/m<sup>2</sup>*</li> <li>· Multiflag® SE, 110 g/m<sup>2</sup></li> </ul>	
<b>Accessories</b>	Cable ties, Bungee ties, Bungee ties with hook and Bungee ties with T-bar			

\*also available as flame retardant model

All sizes are approximate. As we are constantly developing our products we reserve the right of changing technical issues and dimensional deviations.

Fixation of Jackets and Scrims to the barrier



Barrier Jacket made of non-woven polyester

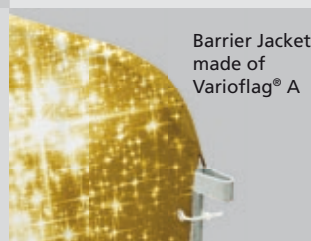

Barrier Jacket made of Varioflag® A

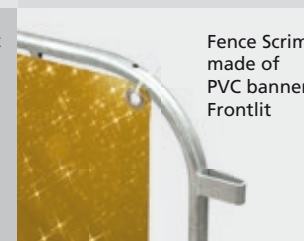

Fence Scrim made of PVC banner Frontlit